

## SLIDE VALVE

### MANUAL TYPES SM & OM

#### MANUAL TYPE SM

- SIZES 100-300mm ROUND OR SQUARE
- SHALLOW OVERALL DEPTH
- MACHINED CAST ALUMINIUM BODY
- STAINLESS STEEL SLIDE PLATE
- FOR IN-LINE USE

A range of low cost manual valves for powders. The shallow overall depth with inlet and outlet flanges identical and no other protrusions allows the valve to be used where vertical height is limited. The felt seal around the slide plate is contained in an adjustable stuffing box. The aluminium alloy body and 304 stainless steel slide plate, running on nylon 66 adjustable supports, permit the valve in its standard form to be used with a wide variety of materials in the chemical, plastics, foodstuffs, etc., industries. Maximum operating temperature 120°C. Also available in all stainless steel.

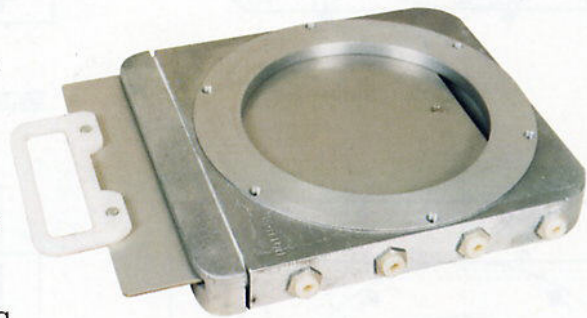

#### MANUAL TYPE OM

- FOR OPEN DISCHARGE ONLY
- SIZES 100-300mm ROUND OR SQUARE
- SHALLOW OVERALL DEPTH
- MACHINED CAST ALUMINIUM BODY
- STAINLESS STEEL SLIDE PLATE

A low cost valve designed especially for use with transportable hoppers containing various powdered and granular material. There is no lower flange and the valve is therefore suitable for open discharge applications only.

The shallow overall depth allows the valve to be used where vertical height is limited. The aluminium alloy body and 304 stainless steel slide plate, running on nylon 66 adjustable supports, permit the valve in its standard form to be used with a wide variety of materials in the chemical, plastics, foodstuffs, etc., industries. Maximum operating temperature 120°C. Also available in all stainless steel.

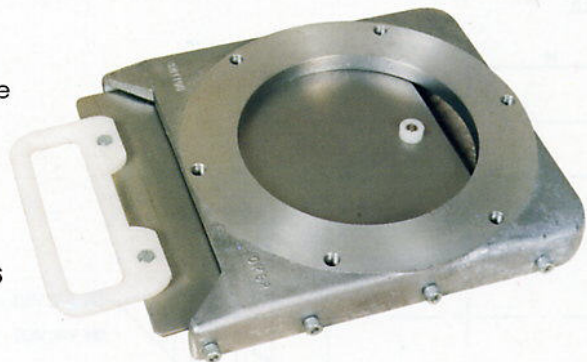

**Britton Procol**  
**VALVES**

See over for  
planning-in  
dimensions



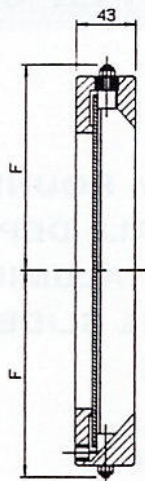
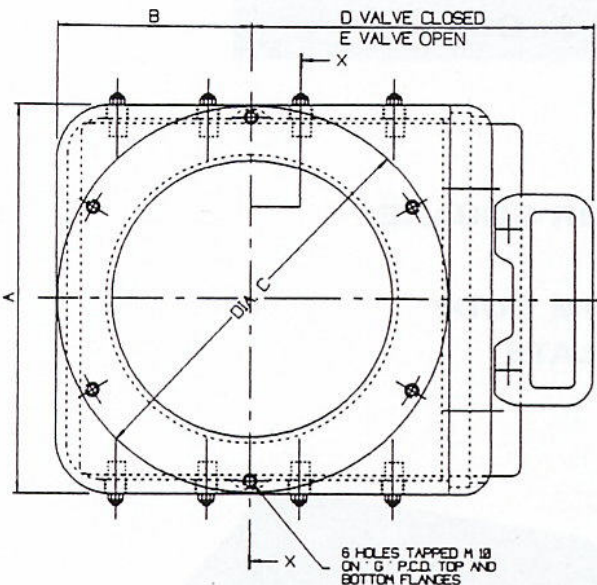

SECTION X - X

**VALVE TYPE SM**

VALVE SIZE	A	B	C	D	E	F	G	H CRS.	wt.
100	182	91	180	195	305	100	162	70	3.2
150	232	116	230	220	380	125	213	95	4.8
200	282	141	280	245	455	150	264	121	6.2
250	332	166	330	270	530	175	314	146	8.0
300	382	191	380	295	605	200	365	171	9.8

Dimensions in mm. Weight in Kgs.

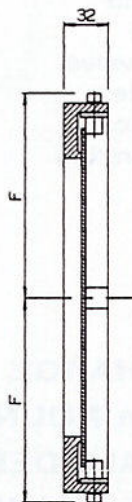
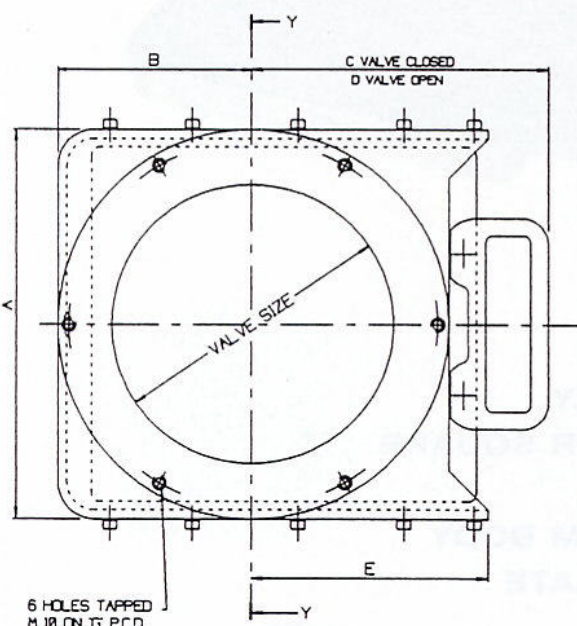

SECTION Y - Y.

**VALVE TYPE OM**

VALVE SIZE	A	B	C	D	E	F	G	H CRS.	wt.
100	180	90	150	250	118	100	162	70	1.7
150	230	115	180	330	143	125	213	95	2.5
200	280	140	210	410	168	150	264	121	3.5
250	330	165	235	485	193	175	314	146	5.0
300	380	190	260	560	234	200	365	171	6.5

Dimensions in mm. Weight in Kgs.

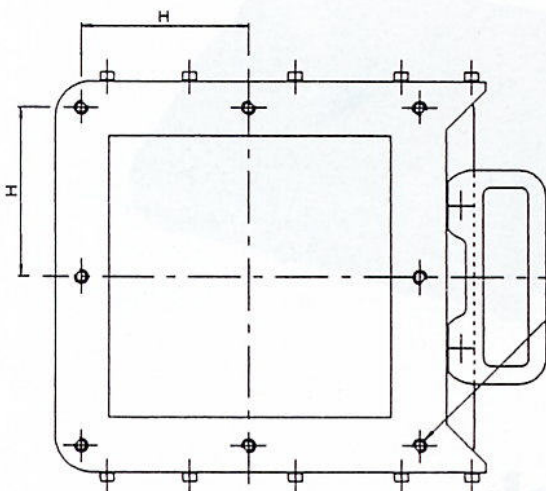

FLANGE DETAIL OF SQUARE VALVES TYPES OM + SM

SM VALVES : 8 HOLES TAP M 10 TOP AND BOTTOM FLANGES  
 OM VALVES : 8 HOLES TAP M 10 TOP FLANGE ONLY

We are continually developing our products and accordingly we reserve the right to change specifications and dimensions without prior notice.

**Britton Procol**  
**VALVES**

BRITTON PROCOL VALVES · KYNOCHS  
 BIDEFORD · DEVON · ENGLAND · EX39 4DT

TEL 01237 477465 · FAX 01237 421459  
 EMAIL [post@britton.dowsongroup.com](mailto:post@britton.dowsongroup.com)  
[www.dowsongroup.com](http://www.dowsongroup.com)